

VORTICE® VARIO RANGE

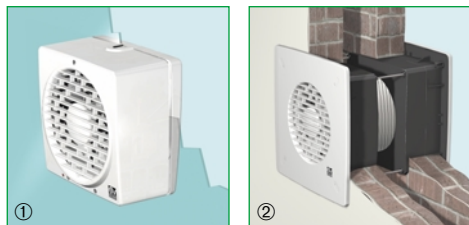

- The new line of Vortice Vario exhaust/supply fans provide a modern and flexible solution to improve the quality of air we breathe daily in any domestic or commercial environment: dwellings, shops & cafes, sports centers/gyms, restaurants, public houses, offices, schools, community halls and many more...
- The new Vortice Vario models are among the best of their category in terms of performance and low energy consumption thanks to highly efficient impellers.
- Published performances and data are third party certified as indicated in IMQ data label.
- Great care has been taken to ensure extremely low noise levels. All technical data has been certified by TUV.
- The outer casing is made from shock-resistant UV stabilised ABS. Structural components in UV resistant ABS, internal components from shock resistant PS.
- Vortice Vario fans are carefully designed to provide a low environmental impact, using recyclable materials and following the new "Design for Disassembly" technique to provide easy and environmentally friendly disposal of components. Vortice avoided polluting

technologies in the production cycle, and even the packaging of the products adopts recycled paper and safe non-polluting inks. Energy consumption is optimised both during production and operation. Noise pollution has also been minimised.

- All fans are IPX4 rated in compliance to IEC EN 60529 standards both inside and outside.
- Vortice Vario fans are EC marked in accordance with the Low Voltage Directive EEC 73/23 and the Electromagnetic Compatibility Directive 89/336. All fans are also IMQ (Italian Safety Institute) certified in compliance with CEI EN 60335-2-80 and CEI EN 60529 standards.

Design: F. Trabucco & Associates

Wiring diagrams shown on page XXXI.

NEW

TELESCOPIC FRAME FOR WALL MOUNTED MODELS

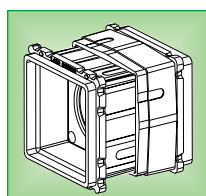

This frame is made of expanded polystyrene and facilitates wall mounting of the Vortice Vario series. Accessory included.

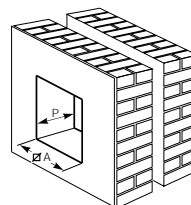

Dimensions (mm)

Model	∅ A	P (min)	P (max)
150/6"	325	220	330
230/9"	400	220	330
300/12"	500	220	330

Dimensions (mm)

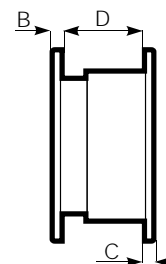
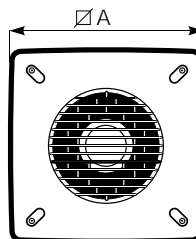
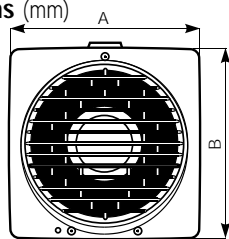

Window/Wall	A	B	C	D	E min/max	hole dia ∅
150/6"	215	218	31	97.5	2/38	185+190
230/9"	294	297	31	130	2/38	257+262
300/12"	390	393	31	147	2/38	324+329

Built-in	∅ A	B	C	D min	installation hole ∅mm
150/6"	300	9.5	10.5	135	260+265
230/9"	400	10	11	180	335+340
300/12"	495	10.5	11.5	210	435+440

EASY AND QUICK TO INSTALL

The whole range is manufactured to match high technology specifications and provide ease of installation. Based on this practical approach all installation procedures are significantly simplified to reduce time and save money during set-up and installation.

HIGH FLEXIBILITY

Vortice Vario fans are designed to provide high flexibility and a wide choice of applications in order to satisfy even the most demanding requirements.



① Model for installation on glass/panel/wall

② Built-in installation.

Note: "Designed for Disassembly" Recyclable in compliance with the WEEE Directive.

Product	Code	V ~ 50/60 Hz	W	A	Rpm	Delivery		Lp dB(A) 3 m	Approvals	kg	Insulation	IP	°C max
						m³/h	l/s						
150/6" P	12611	220-240	18	0.10	1340	235	65.3	37.5		2.07	cl. II	X4	50
230/9" P	12451	220-240	22	0.10	790	480	133	35.6		3.45	cl. II	X4	50
150/6" P LL S	12614	220-240	32	0.16	2110	380	105.6	46.9		2.07	cl. II	X4	50
230/9" P LL S	12454	220-240	32/38	0.18	1200	700	194.4	43.6		3.45	cl. II	X4	50
150/6" AR	12612	220-240	25	0.11	1340 ⁽¹⁾ 2040 ⁽²⁾	235 ⁽¹⁾ 150 ⁽²⁾	65.3 ⁽¹⁾ 41.7 ⁽²⁾	37.5		2.07	cl. II	X4	50
230/9" AR	12452	220-240	26	0.13	790 ⁽¹⁾ 1080 ⁽²⁾	480 ⁽¹⁾ 310 ⁽²⁾	133 ⁽¹⁾ 86 ⁽²⁾	35.6		3.45	cl. II	X4	50
300/12" AR	12412	220-240	45	0.21	840 ⁽¹⁾ 1085 ⁽²⁾	1050 ⁽¹⁾ 700 ⁽²⁾	292 ⁽¹⁾ 194.4 ⁽²⁾	40.2		6.13	cl. II	X4	50(50 Hz) 40(60 Hz)
150/6" AR LL S	12615	220-240	35	0.17	2110 ⁽¹⁾ 2520 ⁽²⁾	380 ⁽¹⁾ 215 ⁽²⁾	105.6 ⁽¹⁾ 59.7 ⁽²⁾	49.6		2.07	cl. II	X4	50
230/9" AR LL S	12455	220-240	35/40	0.19	1200 ⁽¹⁾ 1300 ⁽²⁾	700 ⁽¹⁾ 370 ⁽²⁾	194.4 ⁽¹⁾ 102.8 ⁽²⁾	43.6		3.45	cl. II	X4	50
300/12" AR LL S	12415	220-240	75/90	0.41	1215 ⁽¹⁾ 1280 ⁽²⁾	1650 ⁽¹⁾ 920 ⁽²⁾	458.3 ⁽¹⁾ 255.6 ⁽²⁾	53.6		6.13	cl. II	X4	50(50 Hz) 40(60 Hz)
150/6" ARI	12613	220-240	25	0.11	1330 ⁽¹⁾ 1880 ⁽²⁾	220 ⁽¹⁾ 130 ⁽²⁾	61.1 ⁽¹⁾ 36.1 ⁽²⁾	38.2		2.52	cl. II	X4	50
230/9" ARI	12453	220-240	26	0.13	810 ⁽¹⁾ 1080 ⁽²⁾	450 ⁽¹⁾ 300 ⁽²⁾	125 ⁽¹⁾ 83.3 ⁽²⁾	35.7		3.88	cl. II	X4	50
300/12" ARI	12413	220-240	45	0.21	850 ⁽¹⁾ 1150 ⁽²⁾	1200 ⁽¹⁾ 850 ⁽²⁾	333.3 ⁽¹⁾ 236.1 ⁽²⁾	40.7		7.2	cl. II	X4	50(50 Hz) 40(60 Hz)
150/6" ARI LL S	12616	220-240	35	0.17	2080 ⁽¹⁾ 2460 ⁽²⁾	350 ⁽¹⁾ 200 ⁽²⁾	97.2 ⁽¹⁾ 55.6 ⁽²⁾	49.1		2.52	cl. II	X4	50
230/9" ARI LL S	12456	220-240	35/40	0.19	1160 ⁽¹⁾ 1260 ⁽²⁾	680 ⁽¹⁾ 350 ⁽²⁾	188.9 ⁽¹⁾ 97.2 ⁽²⁾	45.3		3.88	cl. II	X4	50
300/12" ARI LL S	12416	220-240	75/90	0.41	1230 ⁽¹⁾ 1310 ⁽²⁾	1750 ⁽¹⁾ 1000 ⁽²⁾	486.1 ⁽¹⁾ 277.7 ⁽²⁾	53.5		7.20	cl. II	X4	50(50 Hz) 40(60 Hz)

⁽¹⁾Extract - ⁽²⁾Intake

PRODUCT REFERENCES

P	A	R	LL	S	I
PULL CORD Manual	AUTOMATIC Automatic shutters	REVERSIBLE	LONG LIFE Motor with ball bearings	SUPER Boosted performance	BUILT-IN



SINGLE AND DOUBLE-GLAZED WINDOW

Model	Code	Kits required (codes) ⁽¹⁾
150/6° P	12611	none
150/6° P LL S	12614	none
150/6° AR	12612	none
150/6° AR LL S	12615	none
230/9° P	12451	none
230/9° P LL S	12454	none
230/9° AR	12452	none
230/9° AR LL S	12455	none
300/12° AR	12412	none
300/12° AR LL S	12415	none



WINDOW / PANEL MOUNTING WITH EXTERNAL COWL AS A WIND BAFFLE

Model	Code	Kits required (codes)
150/6° P	12611	13001
150/6° P LL S	12614	13001
150/6° AR	12612	13001
150/6° AR LL S	12615	13001
230/9° P	12451	13002
230/9° P LL S	12454	13002
230/9° AR	12452	13002
230/9° AR LL S	12455	13002
300/12° AR	12412	13003
300/12° AR LL S	12415	13003



DOUBLE-GLAZED (OPENING) WINDOW

Model	Code	Kits required (codes) ⁽²⁾
150/6° P	12611	13021
150/6° P LL S	12614	13021
150/6° AR	12612	13021
150/6° AR LL S	12615	13021
230/9° P	12451	13022
230/9° P LL S	12454	13022
230/9° AR	12452	13022
230/9° AR LL S	12455	13022
300/12° AR	12412	13023
300/12° AR LL S	12415	13023



WALL MOUNTING FOR REMOTE APPLICATION

Model	Code	Kits required (codes)
150/6° AR	12612	13001 + 13018 + 2 items 13027
150/6° AR LL S	12615	13001 + 13018 + 2 items 13027
230/9° AR	12452	13002 + 13018 + 2 items 13028
230/9° AR LL S	12455	13002 + 13018 + 2 items 13028
300/12° AR	12412	13003 + 13018 + 2 items 13029
300/12° AR LL S	12415	13003 + 13018 + 2 items 13029

Duct not included



DOUBLE (OPENING) WINDOW SECONDARY-GLAZED

Model	Code	Kits required (codes) ⁽³⁾
150/6° P	12611	13024
150/6° P LL S	12614	13024
150/6° AR	12612	13024
150/6° AR LL S	12615	13024
230/9° P	12451	13025
230/9° P LL S	12454	13025
230/9° AR	12452	13025
230/9° AR LL S	12455	13025
300/12° AR	12412	13026
300/12° AR LL S	12415	13026

Duct included



BUILT-IN WALL MOUNTING

Model	Code	Kits required (codes) ⁽⁵⁾
150/6° ARI	12613	none
150/6° ARI LL S	12616	none
230/9° ARI	12453	none
230/9° ARI LL S	12456	none
300/12° ARI	12413	none
300/12° ARI LL S	12416	none

BUILT-IN DEEP WALL MOUNTING

Model	Code	Kits required (codes)
150/6° ARI	12613	13015
150/6° ARI LL S	12616	13015
230/9° ARI	12453	13016
230/9° ARI LL S	12456	13016
300/12° ARI	12413	13017
300/12° ARI LL S	12416	13017

Duct not included



WALL MOUNTING

Model	Code	Kits required (codes) ⁽⁴⁾
150/6° P	12611	13018
150/6° P LL S	12614	13018
150/6° AR	12612	13018
150/6° AR LL S	12615	13018
230/9° P	12451	13018
230/9° P LL S	12454	13018
230/9° AR	12452	13018
230/9° AR LL S	12455	13018
300/12° AR	12412	13018
300/12° AR LL S	12415	13018



WALL MOUNTING WITH EXTERNAL COWL AS A WIND BAFFLE

Model	Code	Kits required (codes)
150/6° P	12611	13001 + 13018
150/6° P LL S	12614	13001 + 13018
150/6° AR	12612	13001 + 13018
150/6° AR LL S	12615	13001 + 13018
230/9° P	12451	13002 + 13018
230/9° P LL S	12454	13002 + 13018
230/9° AR	12452	13002 + 13018
230/9° AR LL S	12455	13002 + 13018
300/12° AR	12412	13003 + 13018
300/12° AR LL S	12415	13003 + 13018

PANEL / WALL MOUNTING WITH DARKROOM COWL

Model	Code	Kits required (codes)
230/9° P	12451	panel: 13004 - wall: 13004 + 13018
230/9° P LL S	12454	panel: 13004 - wall: 13004 + 13018
230/9° AR	12452	panel: 13004 - wall: 13004 + 13018
230/9° AR LL S	12455	panel: 13004 - wall: 13004 + 13018

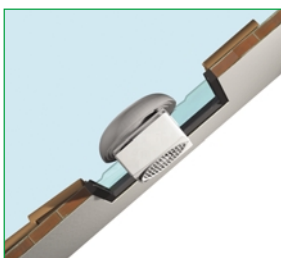

ROOF MOUNTING ON WINDOW / PANEL

Model	Code	Kits required (codes)
150/6° AR	12612	13001
150/6° AR LL S	12615	13001
230/9° AR	12452	13002
230/9° AR LL S	12455	13002
300/12° AR	12412	13003
300/12° AR LL S	12415	13003



BUILT-IN ROOF MOUNTED FOR REMOTE APPLICATION

Model	Code	Kits required (codes)
150/6° ARI	12613	13001 + 13027 + 13012
150/6° ARI LL S	12616	13001 + 13027 + 13012
230/9° ARI	12453	13002 + 13028 + 13012
230/9° ARI LL S	12456	13002 + 13028 + 13012
300/12° ARI	12413	13003 + 13029 + 13014
300/12° ARI LL S	12416	13003 + 13029 + 13014

Duct not included

⁽¹⁾No kit is required for window/panels with thickness ranging from 3 to 38mm

⁽²⁾For installation in double-glazed (opening) window with thickness ranging from 30 to 43mm

⁽³⁾For installation on double (opening) window with thickness ranging from 230 to 300mm.

⁽⁴⁾For installation on walls, with thickness ranging from 38 to 300mm

⁽⁵⁾No kit is required for walls with thickness ranging from 135 to 210mm

AVAILABLE KITS Optional kits for special installations are available on request

Model	Code	Product
Kit MU	13018	Wall mounting kit with rods
Kit FF 150/6"	13024	Double opening window kit, Mod. 150/6" (including special flanges for protective grille holder and double window, gaskets for grille and flange, protective grille, duct and fixings)
Kit FF 230/9"	13025	Double opening window kit, Mod. 230/9" (including special flanges for protective grille holder and double window, gaskets for grille and flange, protective grille, duct and fixings)
Kit FF 300/12"	13026	Double opening window kit, Mod. 300/12" (including special flanges for protective grille holder and double window, gaskets for grille and flange, protective grille, duct and fixings)
Kit VV 150/6"	13021	Double opening window, secondary-glazed kit, Mod. 150/6" (including special flanges for protective grille holder and secondary glazing, gaskets for grille and window, protective grille, duct, nuts and screws)
Kit VV 230/9"	13022	Double opening window, secondary-glazed kit, Mod. 230/9" (including special flanges for protective grille holder and secondary glazing, gaskets for grille and window, protective grille, duct, nuts and screws)
Kit VV 300/12"	13023	Double opening window, secondary-glazed kit, Mod. 300/12" (including special flanges for protective grille holder and secondary glazing, gaskets for grille and window, protective grille, duct, nuts and screws)
Kit TE 150/6"	13001	Roof Cowl/Wind Baffle kit, Mod. 150/6" (including external roof cowl and base, gasket, threaded collar and intermediate rings)
Kit TE 230/9"	13002	Roof Cowl/Wind Baffle kit, Mod. 230/9" (including external roof cowl and base, gasket, threaded collar and intermediate rings)
Kit TE 300/12"	13003	Roof Cowl/Wind Baffle kit, Mod. 230/9" (including external roof cowl and base, gasket, threaded collar and intermediate rings)
Kit ML 150/6"	13015	Deep wall installation kit, Mod. 150/6" (including flush-mounting frame, feet, duct)
Kit ML 230/9"	13016	Deep wall installation kit, Mod. 230/9" (including flush-mounting frame, feet, duct)
Kit ML 300/12"	13017	Deep wall installation kit, Mod. 300/12" (including flush-mounting frame, feet, duct)
Kit SO 150/6" - 230/9"	13012	Ceiling, false ceiling and panel kit, Mod. 150/6" and 230/9" (including 2 ceiling brackets - M5 X 70 - M5 X 30 screws - springs - washers)
Kit SO 300/12"	13014	Ceiling, false ceiling and panel kit, Mod. 300/12" (including 4 ceiling brackets - M5 X 70 - M5 X 30 screws - springs - washers)
Kit TC 150/6"	13027	Spigot Plate for remote application, Mod. 150/6" (including flange for duct, coupling gasket, 4 nuts, 4 screws, M4 X 20/M4 X 50)
Kit TC 230/9"	13028	Spigot Plate for remote application, Mod. 230/9" (including flange for duct, coupling gasket, 4 nuts, 4 screws, M4 X 20/M4 X 50)
Kit TC 300/12"	13029	Spigot Plate for remote application, Mod. 300/12" (including flange for duct, coupling gasket, 4 nuts, 4 screws, M4 X 20/M4 X 50)
Kit SA 230/9"	13004	Darkroom cowl kit, Mod. 230/9" (darkroom and intermediate rings, external baffle and base, gasket, mesh) - UV stabilized material, painted with dark, non-reflective paint

Roof cowl kit

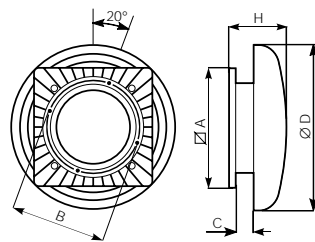

Model	code	Ø D	∅ A	B	C	H
150/6"	13001	300	215	175	28	111
230/9"	13002	400	294	249	30	145
300/12"	13003	534	390	316	33	181

Spigot Plate

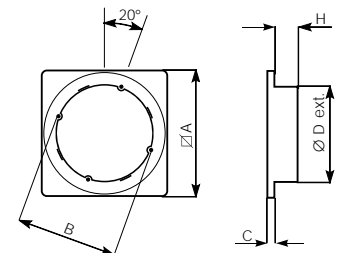

Model	code	Ø D ext.	∅ A	B	C	H
150/6"	13027	171	215	175	8	30
230/9"	13028	240	294	249	10	30
300/12"	13029	300	390	316	12	30

Duct diameter for Spigot Plate

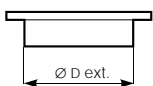

Model	code	Ø D ext.
150/6"	13027	171
230/9"	13028	240
300/12"	13029	300

Duct diameter for flush-mounting frame

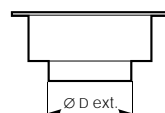

Model	code	Ø D ext.
150/6"	13015	171
230/9"	13016	240
300/12"	13017	300

Diameter of PVC ducts

Light series for ventilation.
Suitable for Vortice applications.
With the following internal diameters.

Model	Ø D int.	Ø D ext.	thickn.
150/6"	176	180	2
230/9"	245	250	2,5
300/12"	309	315	3

Diameter of aluminium ducts

Flexible. Suited for Vortice applications. With the following internal diameters.

Model	Ø D int.
150/6"	171
230/9"	240
300/12"	300

INSTALLATION OPTIONS AND REQUIRED KITS

	Number of required kits	150/6" P	150/6" P L L S	150/6" AR	150/6" AR L L S	150/6" ARI	150/6" ARI L L S	230/9" P	230/9" P L L S	230/9" AR	230/9" AR L L S	230/9" ARI	230/9" ARI L L S	300/12" AR	300/12" AR L L S	300/12" ARI	300/12" ARI L L S
Single-glazed window																	
Wall	1	13018	13018	13018	13018			13018	13018	13018	13018			13018	13018		
Double-glazed (opening) window	1	13021	13021	13021	13021			13022	13022	13022	13022			13023	13023		
Double (opening) window secondary-glazing	1	13024	13024	13024	13024			13025	13025	13025	13025			13026	13026		
Window-mounted with darkroom cowl	1							13004	13004	13004	13004						
Window / panel-mounted with external cowl	1	13001	13001	13001	13001			13002	13002	13002	13002			13003	13003		
Roof application	1			13001	13001					13002	13002			13003	13003		
Wall-mounted with external cowl	2	13001 13018	13001 13018	13001 13018	13001 13018			13002 13018	13002 13018	13002 13018	13002 13018			13003 13018	13003 13018		
Wall-mounted for remote application (duct not included)	1			13001 13018 13027x2	13001 13018 13027x2					13002 13018 13028x2	13002 13018 13028x2			13003 13018 13029x2	13003 13018 13029x2		
Built-in wall mounted																	
Built-in deep wall mounted	1					13015	13015					13016	13016			13017	13017
Panel																	
Ceiling	1					13012	13012					13012	13012			13014	13014
False ceiling																	
Roof-mounted for remote application (duct not included)	3					13001 13027 13012	13001 13027 13012					13002 13028 13012	13002 13028 13012			13003 13029 13014	13003 13029 13014
Built-in wall mounted for remote application (duct not included)	3					13027 13012 13015	13027 13012 13015					13028 13012 13016	13028 13012 13016			13029 13014 13017	13029 13014 13017
Thin wall mounted for remote application (duct not included)	3			13001 13018 13027 13012	13001 13018 13027 13012					13002 13018 13028 13012	13002 13018 13028 13012			13003 13018 13029 13014	13003 13018 13029 13014		
Panel-mounted with darkroom cowl	1							13004	13004	13004	13004						
Wall-mounted with darkroom cowl	2							13004 13018	13004 13018	13004 13018	13004 13018						

*Ducting

Code	Model
8501	175 mm flexible duct 3m length
8511	175 mm flexible duct 10m length
8502	243 mm flexible duct 3m length
8512	243 mm flexible duct 10m length
8503	305 mm flexible duct 3m length
8513	305 mm flexible duct 10m length

*Soaker sheet with integral upstand

Code	Model
8550	Soaker Sheet with integral upstand 150/6"
8551	Soaker Sheet with integral upstand 230/9"
8552	Soaker Sheet with integral upstand 300/12"

*Flat roof upstand

Code	Model
8558	Flat Roof Upstand 150/6"
8559	Flat Roof Upstand 230/9"
8560	Flat Roof Upstand 300/12"

*Wall liner

Code	Model
9105	Wall Liner for 150/6" x 275 mm
9108	Wall Liner for 230/9" x 275 mm
9110	Wall Liner for 300/12" x 275 mm

* Available only in UK

Pressure/performance curves

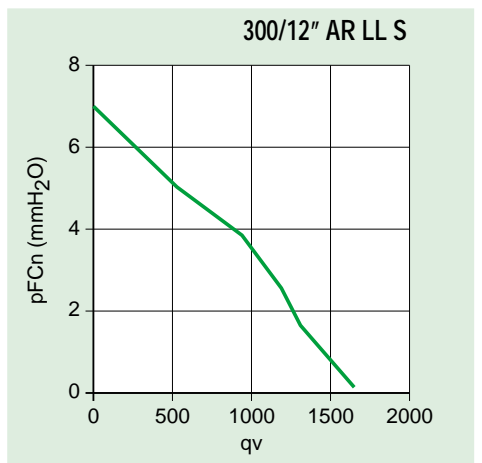
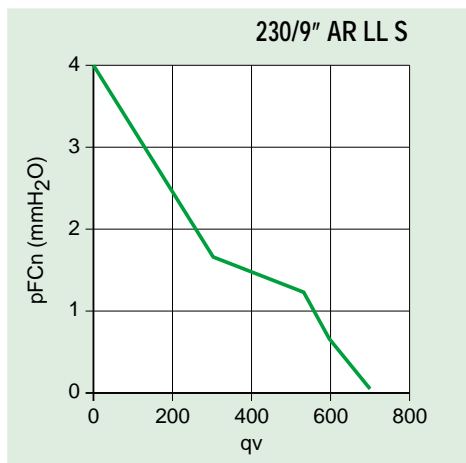
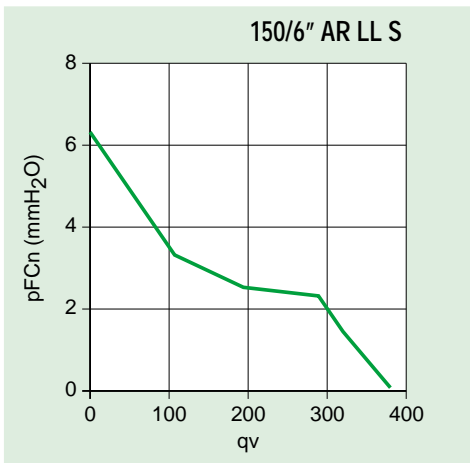
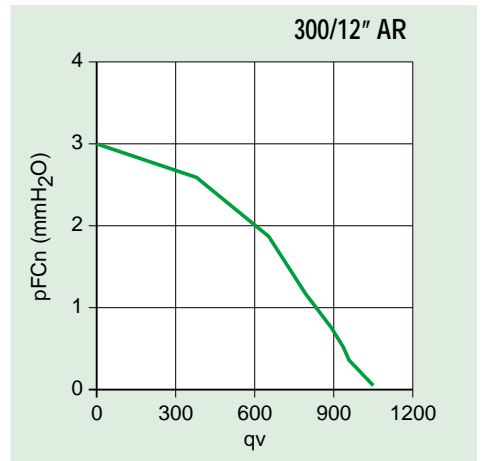
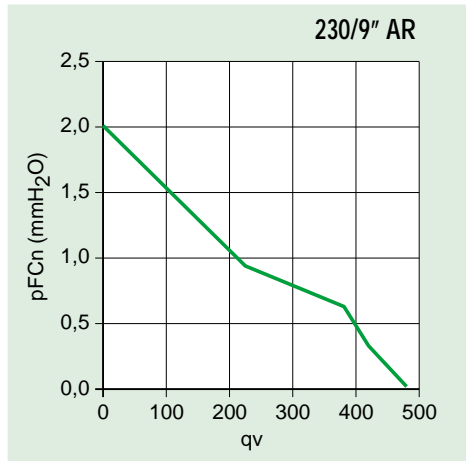
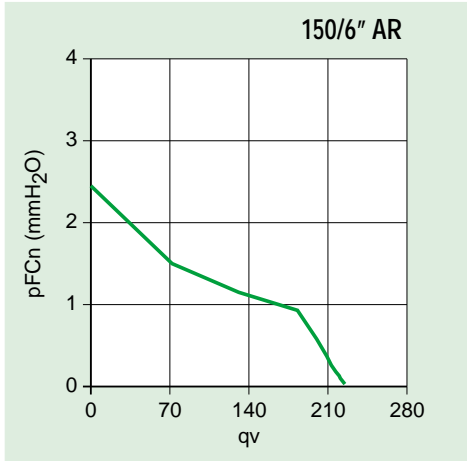

CONTROLLERS

*Wall mounted reversible speed controllers suitable for use with the automatic Vortice Vario models.

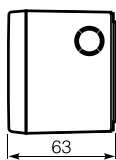
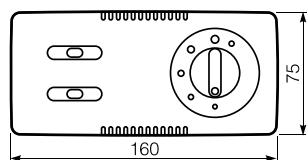

- Supply power: 220-240 V
- Frequency: 50/60Hz
- Operating temperature: 50 °C
- Protection class: IP20
- The controller can also be recessed using a suitable backbox.

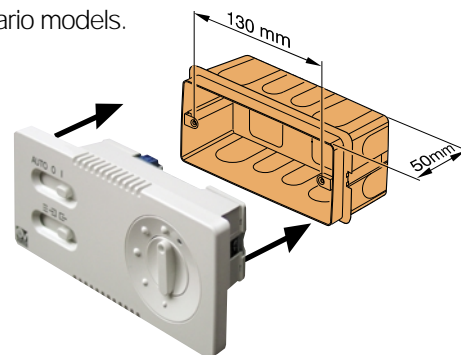

- It can control more than one exhaust fan at the time for a maximum load of 100 W



CR5

(code 12943)

- 5 speed controller
- On/Off
- Reversible
- Can be used to regulate more than one fan.
- Maximum load 100 W.



CR5N

(code 12941)

- 5 speed controller
- On/Off
- Reversible
- Natural Ventilation
- Can be used to regulate more than one fan
- Maximum load 100 W

- It can control more than one exhaust fan at the time for a maximum load of 100 W



CRN

(code 12945)

- On/Off
- Reversible
- Natural Ventilation
- Can be used to regulate more than one fan
- Maximum load 100 W



CREN

(code 12944)

- Variable electronic speed controller
- On/Off
- Reversible
- Natural Ventilation
- Can be used to regulate more than one fan
- Maximum load 1,2 A



Televortice

(code 22391)

- Infrared remote control
- 3 speeds
- On/Off
- Reversible

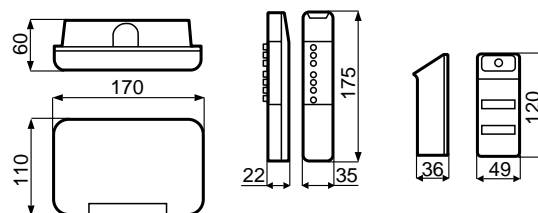

ENVIRONMENTAL SENSORS

Environmental sensors are designed to detect specific environmental conditions (humidity, temperature, presence of a moving body and air quality) and suitable for use with all Vortice Vario models. These sensors can also be connected to the CR range of Vario speed controllers.

- Supply power: 220-240 V
- Frequency: 50/60Hz
- Maximum load: 3 A
- Operating temperature: 50 °C
- Protection class: IP20

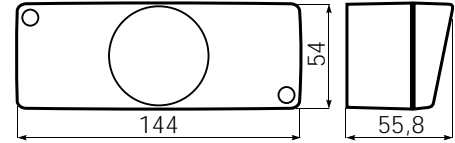

C HCS-HUMIDITY

(code 12994)

Measures ambient relative humidity (R.H.), and starts the Vortice Vario fan when the R.H. exceeds 65%, adjustable.

The sensor can also be wired to allow the unit to be switched on when the R.H. is below 65%, and incorporates an over-run timer (adjustable between 3 and 20 minutes).



C PIR-MOVEMENT DETECTOR

(code 12998)

Detects the presence of a moving body within its sensor range, and starts the fan automatically. The built-in over-run timer can be adjusted between 3 and 20 minutes.



C TIMER

(code 12999)

Adjustable over-run timer (adjustable between 3 and 20 minutes).



C TEMP-TEMPERATURE

(code 12992)

Measures ambient room temperature, and starts the Vortice Vario fan when the temperature exceeds the preset value, adjustable. Once the temperature drops below the adjustable preset value, the unit will over-run for between 3 and 20 minutes (dependent on setting).



C SMOKE

(code 12993)

Measures the air quality, detecting the presence of cigarette smoke, odours and other pollutants, and starts the Vortice Vario fan when the concentration of pollutants exceeds the preset value, adjustable. The unit will also over-run for between 3 and 20 minutes (dependent on setting).